

Type TFLF Automotive Fuse Link Female Terminals



www.optifuse.com (800) 621-0326

Specifications:

Voltage: Up to 58VDC

Amperage: 20A, 30A, 40A, 50A, 60A, 70A, 80A

Current Cycling (Ambient temperature: 24°C):

The fuses satisfy the performance requirements after 50% of the rated current is applied for 10,000 Cycles. Each cycle consists of an interrupted current with the pattern of 5 min. On and 10 min. Off.

% Change in Fuse Current Carrying Capacity:

With change in ambient temperature: -0.075%/°C.

Slow Blow Fuse Table:

Part Number	Ampere Rating	Housing Color
TFLF-20A	20A	Light Blue
TFLF-30A	30A	Pink
TFLF-40A	40A	Green
TFLF-50A	50A	Red
TFLF-60A	60A	Yellow
TFLF-70A	70A	Brown
TFLF-80A	80A	Black

Time-Current Characteristics:

(Ambient temperature: 24°C)

% of Ampere Rating	Operating Time	
	Minimum	Maximum
110%	10 Hours	----
200%	5 Sec.	100 Sec.
350%	0.2 Sec.	7 Sec.
600%	0.04 Sec.	1 Sec.

Mechanical Dimensions: Inches[mm]

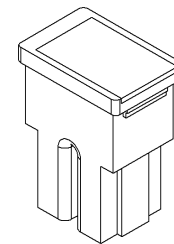
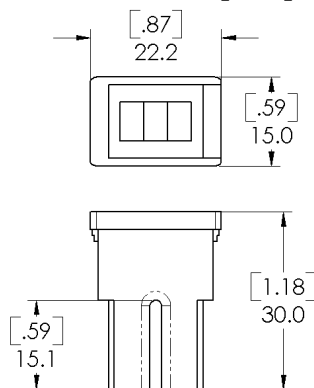

	Warning: -Operation beyond the specified maximum ratings or improper use may result in damage and possible electrical arcing and/or flame.
	-Device are intended for occasional overcurrent protection. Application for repeated overcurrent condition and/or prolonged trip are not anticipated.
	-Avoid contact of device with chemical solvent. Prolonged contact will damage the device performance.