

Type FMX

Automotive Fuse Link

JCASE® Mini Female Terminal



www.optifuse.com

(619) 593-5050

Specifications:

Voltage: 32 VDC

Amperage: 20A, 30A, 40A, 50A, 60A

Interrupting Rating: 1,500A @ 32 VDC

Agency Standards and Listings:

ISO 8820-4:2002

Time Characteristics		
% of rated current	Min hold time	Max hold time
110%	4h	
200%	5s	100s
350%	200ms	7s
600%	40ms	1s

Part Number	Ampere Rating	Housing Color
FMX-20A	20A	Light-Blue
FMX-30A	30A	Pink
FMX-40A	40A	Green
FMX-50A	50A	Red
FMX-60A	60A	Yellow

Mechanical Dimensions: Inches [mm]

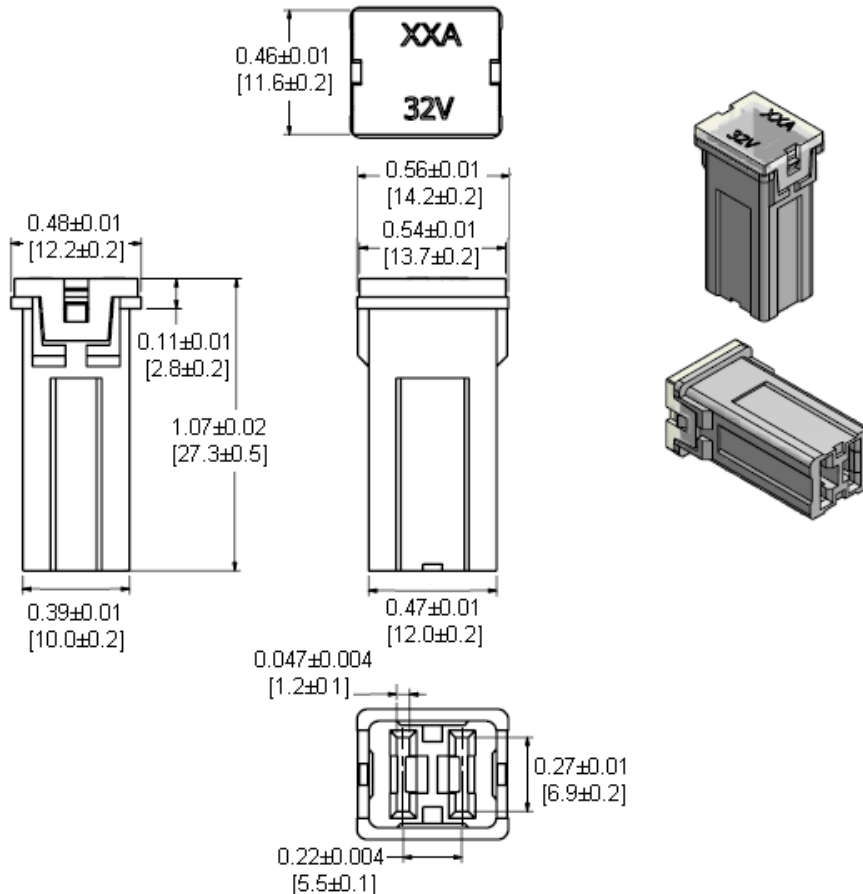

Warning:



-Operation beyond the specified maximum ratings or improper use may result in damage and possible electrical arcing and/or flame.

-Avoid contact of device with chemical solvent. Prolonged contact will damage the device performance.